

JVC

SERVICE MANUAL

CD RECEIVER

KD-DB101EX, KD-DB101EY

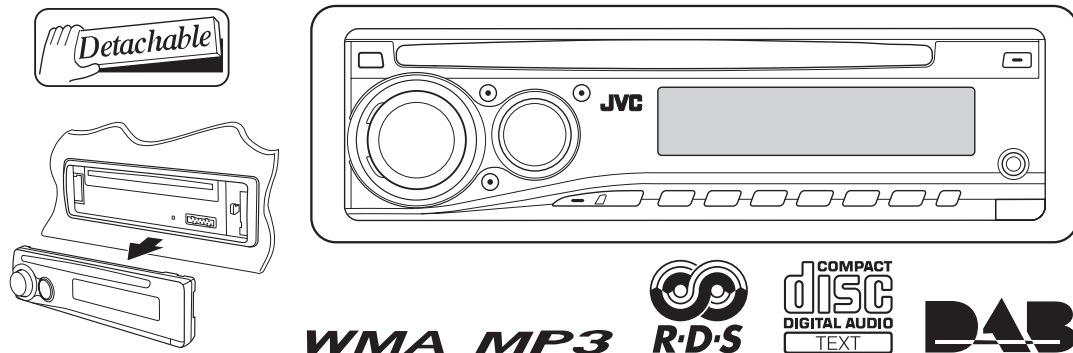

Lead free solder used in the board (material : Sn-Ag-Cu, melting point : 219 Centigrade)
Lead free solder used in the board (material : Sn-Cu, melting point : 230 Centigrade)

TABLE OF CONTENTS

1	PRECAUTION.....	1-3
2	SPECIFIC SERVICE INSTRUCTIONS.....	1-6
3	DISASSEMBLY.....	1-7
4	ADJUSTMENT.....	1-9
5	TROUBLESHOOTING.....	1-10

SPECIFICATION

AUDIO AMPLIFIER SECTION

Maximum Power Output	Front/Rear	50 W per channel
Continuous Power Output (RMS)	Front/Rear	19 W per channel into 4 Ω , 40 Hz to 20 000 Hz at no more than 0.8% total harmonic distortion.
Load Impedance		4 Ω (4 Ω to 8 Ω allowance)
Tone Control Range	Bass	± 10 dB at 100 Hz
	Treble	± 10 dB at 10 kHz
Frequency Response		40 Hz to 20 000 Hz
Signal-to-Noise Ratio		70 dB
Line-Out Level/Impedance		2.5 V/20 k Ω load (full scale)
Output Impedance		1 k Ω
Other Terminals		Steering wheel remote input, AUX (auxiliary) input jack

TUNER SECTION

Frequency Range	FM	87.5 MHz to 108.0 MHz
	AM	MW: 522 kHz to 1 620 kHz LW: 144 kHz to 279 kHz
FM Tuner	Usable Sensitivity	11.2 dBf (1.0 μ V/75 Ω)
	50 dB Quieting Sensitivity	16.3 dBf (1.8 μ V/75 Ω)
	Alternate Channel Selectivity (400 kHz)	65 dB
	Frequency Response	40 Hz to 15 000 Hz
	Stereo Separation	35 dB
MW Tuner	Sensitivity/Selectivity	20 μ V/35 dB
LW Tuner	Sensitivity	50 μ V
DAB Tuner	Sensitivity	-100 dBm (Band III)/-98 dBm (L-Band)
	Selectivity	40 dB

CD PLAYER SECTION

Type	Compact disc player
Signal Detection System	Non-contact optical pickup (semiconductor laser)
Number of Channels	2 channels (stereo)
Frequency Response	5 Hz to 20 000 Hz
Dynamic Range	96 dB
Signal-to-Noise Ratio	98 dB
Wow and Flutter	Less than measurable limit
MP3 Decoding Format: (MPEG1/2 Audio Layer 3)	Max. Bit Rate : 320 kbps
WMA (Windows Media® Audio) Decoding Format	Max. Bit Rate : 192 kbps

GENERAL

Power Requirement	Operating Voltage	DC 14.4 V (11 V to 16 V allowance)
Grounding System		Negative ground
Allowable Operating Temperature		0°C to +40°C
Dimensions (W × H × D) (approx.)	Installation Size	182 mm × 52 mm × 150 mm
	Panel Size	188 mm × 58 mm × 13 mm
Mass		1.4 kg (excluding accessories)

Design and specifications are subject to change without notice.

SECTION 1 PRECAUTION

1.1 Safety Precautions

 **CAUTION** Burrs formed during molding may be left over on some parts of the chassis. Therefore, pay attention to such burrs in the case of performing repair of this system.

 **CAUTION** Please use enough caution not to see the beam directly or touch it in case of an adjustment or operation check.

1.2 Preventing static electricity

Electrostatic discharge (ESD), which occurs when static electricity stored in the body, fabric, etc. is discharged, can destroy the laser diode in the traverse unit (optical pickup). Take care to prevent this when performing repairs.

1.2.1 Grounding to prevent damage by static electricity

Static electricity in the work area can destroy the optical pickup (laser diode) in devices such as laser products.

Be careful to use proper grounding in the area where repairs are being performed.

(1) Ground the workbench

Ground the workbench by laying conductive material (such as a conductive sheet) or an iron plate over it before placing the traverse unit (optical pickup) on it.

(2) Ground yourself

Use an anti-static wrist strap to release any static electricity built up in your body.

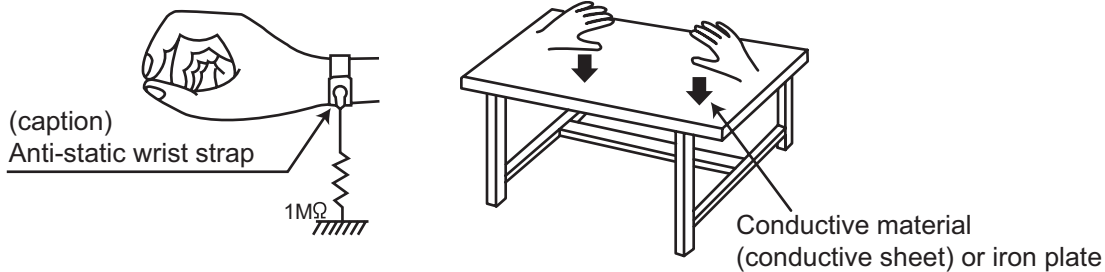

(3) Handling the optical pickup

- In order to maintain quality during transport and before installation, both sides of the laser diode on the replacement optical pickup are shorted. After replacement, return the shorted parts to their original condition. (Refer to the text.)
- Do not use a tester to check the condition of the laser diode in the optical pickup. The tester's internal power source can easily destroy the laser diode.

1.3 Handling the traverse unit (optical pickup)

- (1) Do not subject the traverse unit (optical pickup) to strong shocks, as it is a sensitive, complex unit.
- (2) Cut off the shorted part of the flexible cable using nippers, etc. after replacing the optical pickup. For specific details, refer to the replacement procedure in the text. Remove the anti-static pin when replacing the traverse unit. Be careful not to take too long a time when attaching it to the connector.
- (3) Handle the flexible cable carefully as it may break when subjected to strong force.
- (4) It is not possible to adjust the semi-fixed resistor that adjusts the laser power. Do not turn it.

1.4 Attention when traverse unit is decomposed

***Please refer to "Disassembly method" in the text for the pickup unit.**

- Apply solder to the short land before the card wire is disconnected from the connector on the pickup unit. (If the card wire is disconnected without applying solder, the pickup may be destroyed by static electricity.)
- In the assembly, be sure to remove solder from the short land after connecting the card wire.

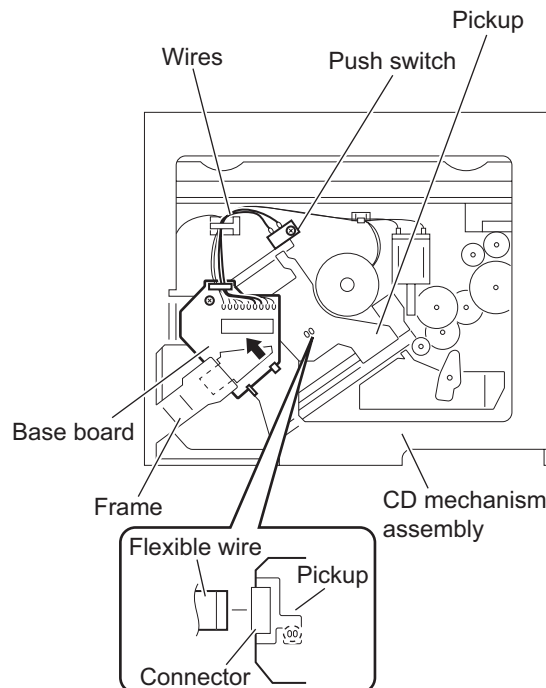

1.5 Important for laser products

1. CLASS 1 LASER PRODUCT

2. CAUTION :

(For U.S.A.) Visible and/or invisible class II laser radiation when open. Do not stare into beam.
(Others) Visible and/or invisible class 1M laser radiation when open. Do not view directly with optical instruments.

3. CAUTION : Visible and/or invisible laser radiation when open and inter lock failed or defeated. Avoid direct exposure to beam.

4. CAUTION : This laser product uses visible and/or invisible laser radiation and is equipped with safety switches which prevent emission of radiation when the drawer is open and the safety interlocks have failed or are defeated. It is dangerous to defeat the safety switches.

(For U.S.A.)

CAUTION : Visible and/or invisible class II laser radiation when open. Do not stare into beam.

(Others)

CAUTION : Visible and/or invisible class 1M laser radiation when open. Do not view directly with optical instruments

ACHTUNG: Sichtbare und/oder unsichtbare Laserstrahlung der Klasse 1M bei offenen Abdeckungen. Nicht direkt mit optischen Instrumenten betrachten.

ATTENTION: Rayonnement laser visible et/ou invisible de classe 1M une fois ouvert. Ne pas regarder directement avec des instruments optiques.

VOORZICHTIG: Zichtbare en/of onzichtbare klasse 1M laserstralen indien geopend. Bekijk niet direct met optische instrumenten.

ATTENZIONE: Radiazione laser in classe 1M visibile e/o invisibile quando aperto. Non osservare direttamente con strumenti ottici.

WARNING: Synlig och/eller osynlig laserstrålning, klass 1M, när denna del är öppnad. Betrakta ej strålen med optiska instrument.

VARO! Avattaessa olet alttiina näkyvälle ja/tai näkymättömälle luokan 1M lasersäteilylle. Älä tarkastele sitä optisen laitteen läpi.

ADVARSEL: Synlig og/eller usynlig klasse 1M-laserstråling ved åbning. Se ikke direkte med optiske instrumenter.

AVISO: Radiación láser de clase 1M visible y/o invisible cuando está abierto. No mirar directamente con instrumental óptico.

PRECAUÇÃO: Radiação laser de classe 1M visível e/ou invisível quando aberto. Não olhe diretamente com instrumentos ópticos.

5. CAUTION : If safety switches malfunction, the laser is able to function.

6. CAUTION : Use of controls, adjustments or performance of procedures other than those specified here in may result in hazardous radiation exposure.

CAUTION Please use enough caution not to see the beam directly or touch it in case of an adjustment or operation check.

PRECAUÇÃO: Radiação laser de classe 1M visível e/ou invisível quando aberto. Não olhe diretamente com instrumentos ópticos.

ПРЕДУПРЕЖДЕНИЕ: В открытом состоянии происходит видимое и/или невидимое излучение лазера класса 1M. Не смотрите непосредственно в оптические инструменты.

UWAGA: Otwarcie spowoduje narażenie na widzialne i/lub niewidzialne promieniowanie lasera klasy 1M. Nie patrzeć bezpośrednio w przyrządy optyczne.

UPOZORNĚNÍ: Při otevření vydává viditelné popř. neviditelné laserové ozáření třídy 1M. Nedívejte se do otvoru přímo s optickými nástroji.

FIGYELMEZTETÉS: Látható és/vagy láthatatlan 1M osztályú sugárzás nyitott állapotban. Ne nézze közvetlenül optikai műszerekkel.

注意：打開蓋板可能會產生可見或不可見的 1M 級鐳射。不要使用光學儀器直接進行窺視。

注意：打开盖板可能会产生可见或不可见的 1M 级鐳射。不要使用光学仪器直接进行窺視。

تنبيه: يوجد إشعاع ليزري مرئي و/أو غير مرئي من الفئة 1M عندما يكون الجهاز مفتوحاً. تجنب النظر مباشرة داخل الجهاز باستخدام أدوات بصرية.

احتياط: هنگامی که باز گردد، تشعشع مرئی و یا نامرئی کلاس 1M لیزر وجود دارد. با لوازم چشمی مستقیماً به آن نگاه نکنید.

주의: 개방하면 가지 및/또는 비가시 클래스 1M 레이저 방사선이 나옵니다. 광학 기구로 직접 들여다보지 마십시오.

REPRODUCTION AND POSITION OF LABELS and PRINT WARNING LABEL and PRINT

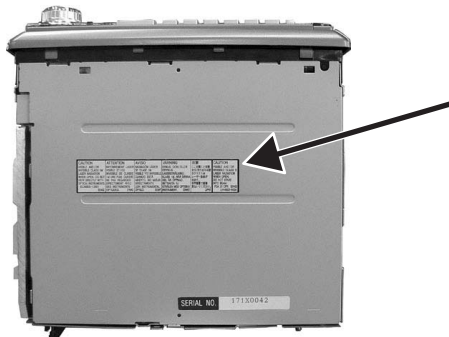

CAUTION VISIBLE AND/OR INVISIBLE CLASS 1M LASER RADIATION WHEN OPEN. DO NOT VIEW DIRECTLY WITH OPTICAL INSTRUMENTS. IEC30025-1:2001 (ENG)	ATTENTION RAYONNEMENT LASER VISIBLE ET/OU INVISIBLE DE CLASSE 1M UNE FOIS OUVERT. NE PAS REGARDER DIRECTEMENT AVEC DES INSTRUMENTS OPTIQUES. (FRA)	AVISO RADIACIÓN LÁSER DE CLASE 1M VISIBLE Y/O INVISIBLE CUANDO ESTA ABIERTO. NO MIRAR DIRECTAMENTE CON INSTRUMENTAL ÓPTICO. (ESP)	WARNING SYNLIG OCH/ELLER OSYNLIG LASERSTRÅLNING, KLASS 1M, NÄR DENNA DEL ÄR ÖPPNAD. BETRAKTA EJ STRÅLEN MED OPTISKA INSTRUMENT. (SWE)	注意 ここに書くと可視 及び/または不可視 のクラス1M レーザー放射が 出ます。 光学装置で直接 見ないでください。 (JPN)	CAUTION VISIBLE AND/OR INVISIBLE CLASS I LASER RADIATION WHEN OPEN. DO NOT STARE INTO BEAM. FDA 21 CFR (ENG) LV44803-003A
--	--	---	---	--	--

SECTION 2
SPECIFIC SERVICE INSTRUCTIONS

This service manual does not describe SPECIFIC SERVICE INSTRUCTIONS.

SECTION 3 DISASSEMBLY

3.1 Main body

3.1.1 Removing the BOTTOM COVER

(See Fig.1)

- (1) Disengage five hooks **a** engaged the BOTTOM COVER.

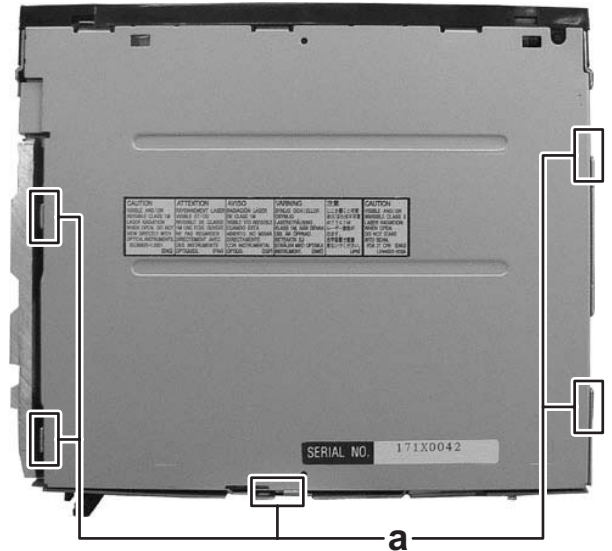

Fig.1

3.1.2 Removing the HEAT SINK

(See Fig.2)

- (1) Remove the two screws **A** and one screw **B** attaching the HEAT SINK.

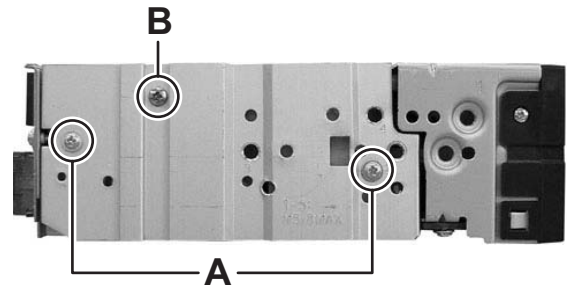
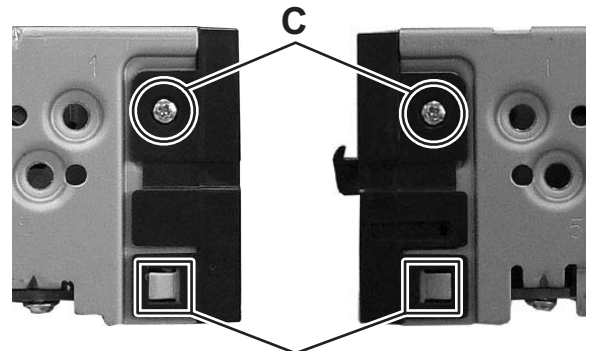

Fig.2

3.1.3 Removing the FRONT CHASSIS

(See Fig.3)

- (1) Remove the two screws **C** attaching the both side of FRONT CHASSIS.
- (2) Disengage two hooks **b** engaged the both side of FRONT CHASSIS.



hook **a**

Fig.3

3.1.4 Removing the REAR BRACKET (See Fig.4)

- (1) Remove the one screw **D** attaching the LINE OUT JACK.
- (2) Remove the one screw **E** attaching the ANTENNA CABLE.
- (3) Remove the one screw **F** attaching the DAB ANTENNA terminal.
- (4) Remove the one screw **G** attaching the REMOTE CABLE.
- (5) Remove the one screw **H** attaching the IC bracket.
- (6) Remove the three screws **J** attaching the REAR BRACKET.

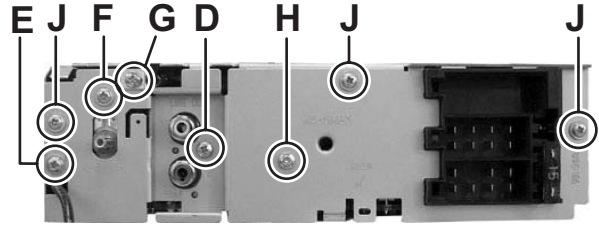

Fig.4

3.1.5 Removing the MAIN BOARD assembly (See Fig.5)

- (1) Remove the two screws **K** attaching the MAIN BOARD assembly.
- (2) Disconnect the connector [CN501](#) connected MAIN BOARD assembly and CD mechanism assembly.

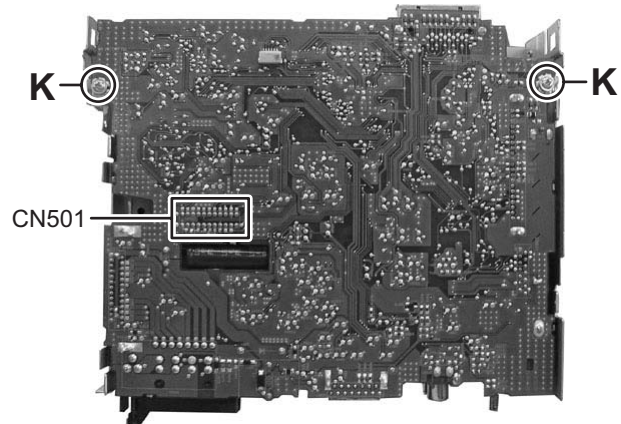

Fig.5

3.1.6 Removing the CD mechanism assembly (See Fig.6)

- (1) Remove the three screws **L** attaching the CD mechanism assembly.

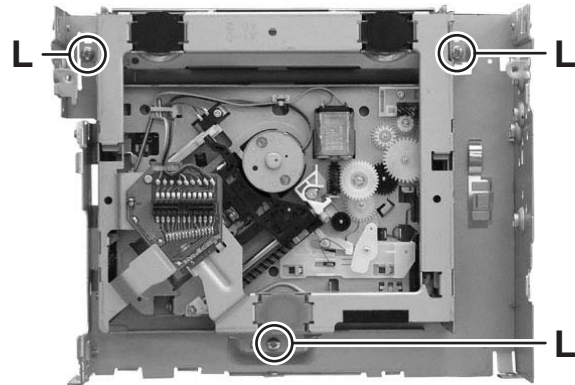

Fig.6

3.1.7 Removing the REAR COVER (See Fig.7)

- (1) Remove the VOLUME KNOB.
- (2) Remove the five screws **M** attaching the REAR COVER.
- (3) Disengage fourteen hooks **c** engaged the REAR COVER.

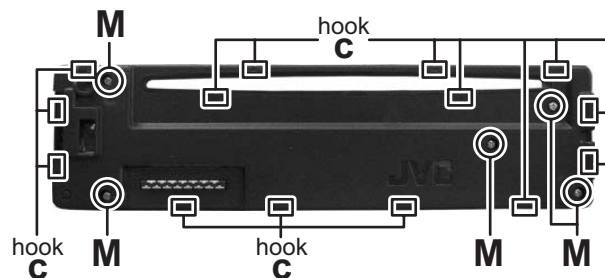

Fig.7

3.2 CD mechanism assembly section

For CD mechanism assembly, please refer the service manual TN2007-1010 , [No.MY005](#) and [No.MY005B](#).

SECTION 4 ADJUSTMENT

4.1 Adjustment method

■ Test instruments required for adjustment

- (1) Digital oscilloscope (100MHz)
- (2) Electric voltmeter
- (3) Digital tester
- (4) Tracking offset meter
- (5) Test Disc JVC: CTS-1000
- (6) Extension cable for check
EXTSH002-22P × 1

■ Standard volume position

Balance and Bass & Treble volume: Indication "0"
Loudness: OFF

■ How to connect the extension cable for adjustment

CAUTION:

Be sure to attach the heat sink and rear bracket onto the power amplifier and regulator respectively, before supply the power.
If voltage is applied without attaching those parts, the power amplifier IC and regulator IC will be destroyed by heat.

■ Dummy load

Exclusive dummy load should be used for AM, and FM. For FM dummy load, there is a loss of 6dB between SSG output and antenna input. The loss of 6dB need not be considered since direct reading of figures are applied in this working standard.

■ Standard measuring conditions

Power supply voltage: DC14.4V(10.5 - 16V)
Load impedance: 20K Ω (2 Speakers connection)
Output Level: Line out 2.0V (Vol. MAX)

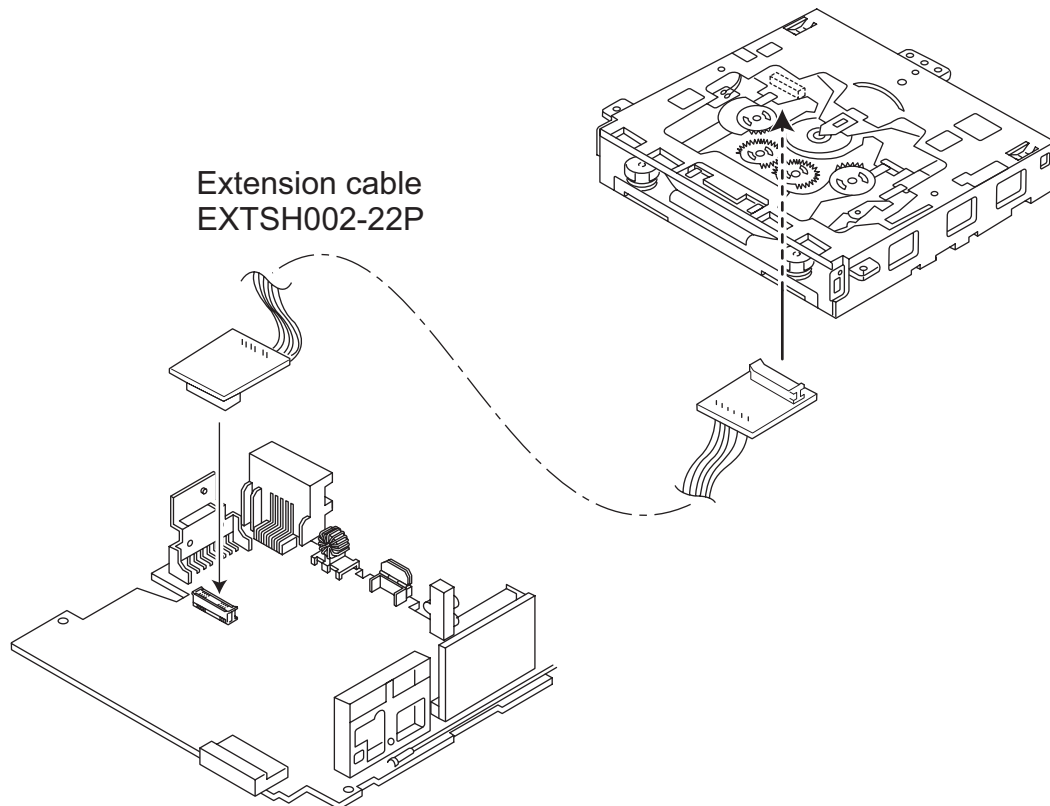

SECTION 5 TROUBLESHOOTING

5.1 16 PIN CORD DIAGRAM

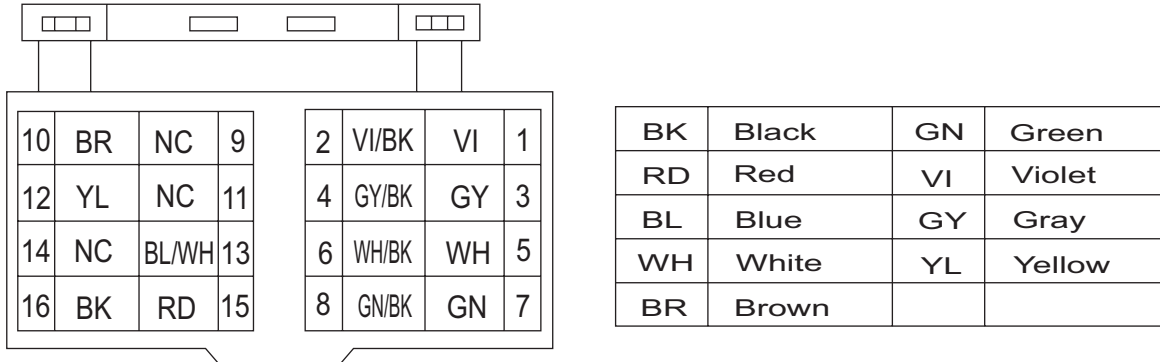

RR	Rear Right	ANT	Auto Antenna
FR	Front Right	ACC	ACC Line
FL	Front Left	TEL	Telephone Muting
RL	Rear Left	GND	Ground
REMOTE	Remote out	MEMORY	Memory Backup Battery+



JVC

Victor company of Japan, Limited
Mobile Entertainment Business Group Mobile Entertainment Category 10-1,1chome,Ohwatari-machi,Maebashi-city,Gumma-ken, 371-8543,Japan

(No.MA319)